

# CREATE YOUR CUSTOM NOTEBOOK IN 4 EASY STEPS



118181

Camri Full Colour Notebook – Medium

01

Provide Artwork for Cover

ARTWORK ATTACHED?

YES

NO

02

Choose Paper



Lined



Unlined

03

Provide Artwork for Custom Pages (Optional)

The first and last 10 pages of the notebook can be customised.



One Colour



Full Colour

ARTWORK ATTACHED?

YES

NO

04

Provide Artwork for Paper Belly Band (Optional)

ARTWORK ATTACHED?

YES

NO

70% of Actual Size  
Digital Print Cover

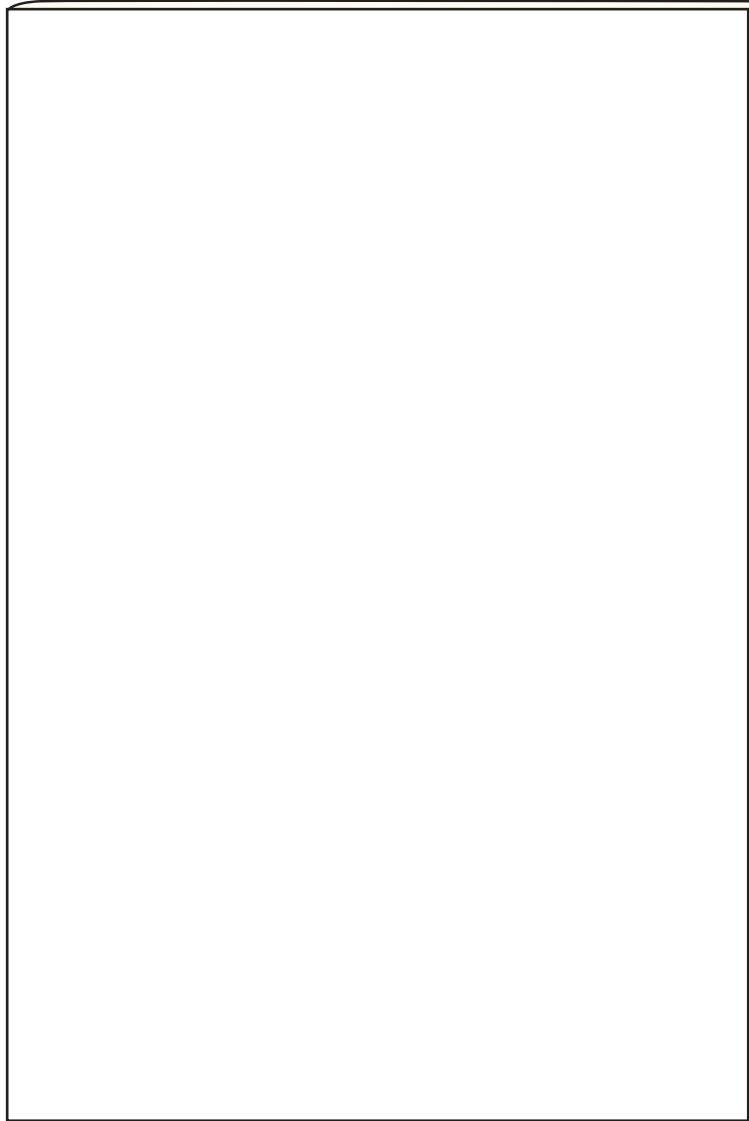

FRONT COVER



BACK COVER

70% of actual size  
Digital Print - Front Cover Template

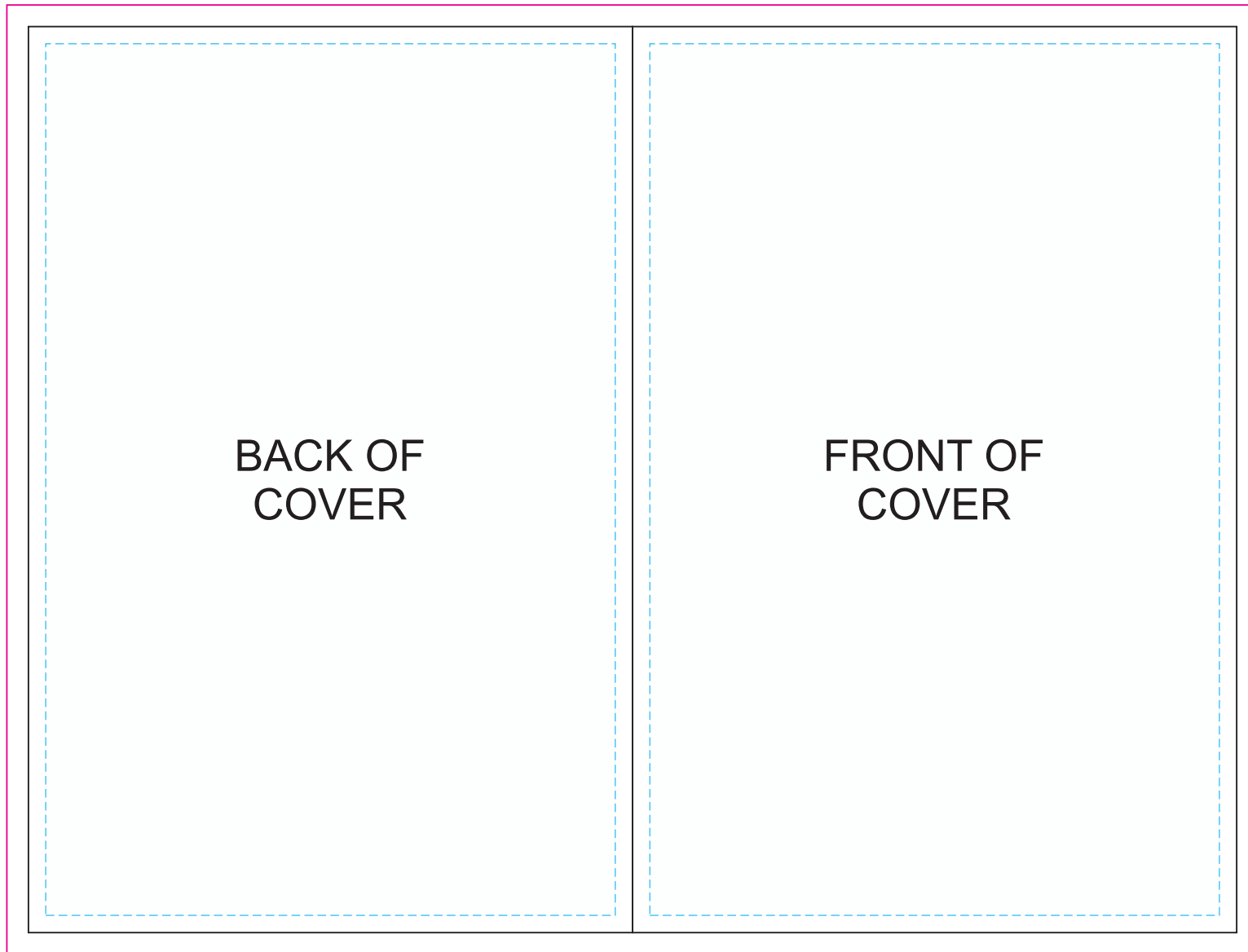

BACK OF  
COVER

FRONT OF  
COVER

BACK

FRONT

70% of Actual Size  
Digital Print - Inside cover

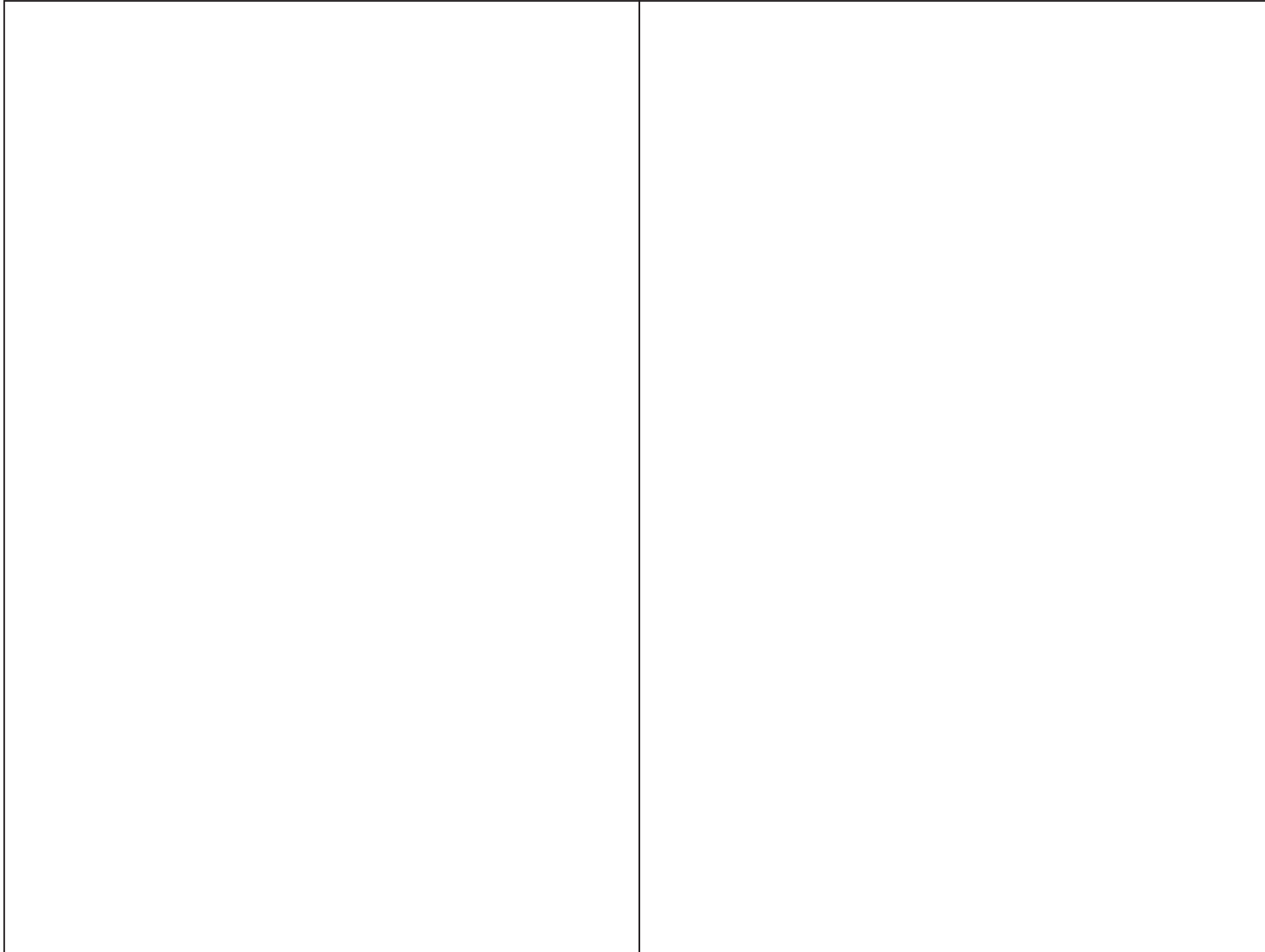

INSIDE OF FRONT WHEN OPENED

INSIDE OF BACK WHEN OPENED

70% of actual size  
Digital Print - Inside Cover Template

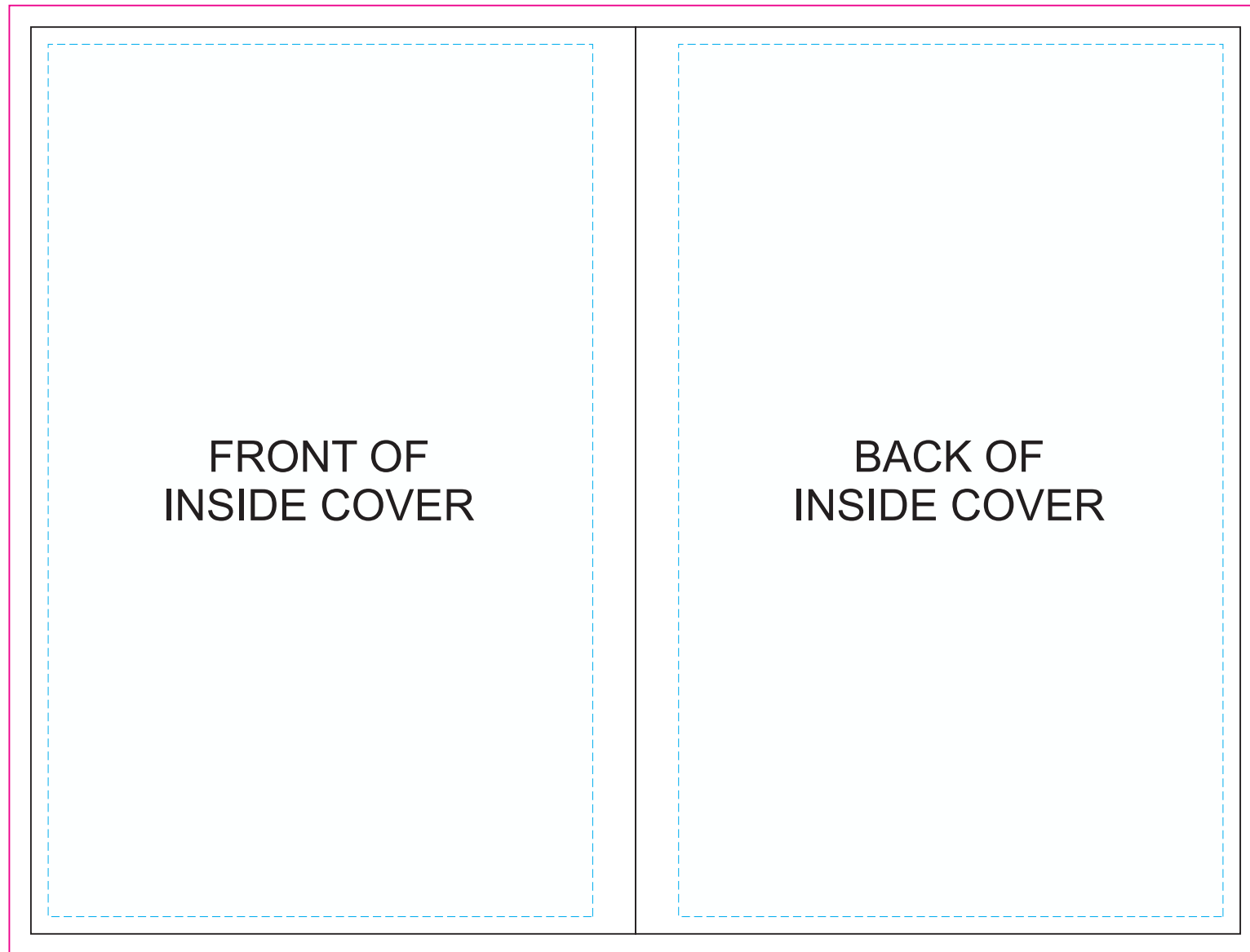

FRONT OF  
INSIDE COVER

BACK OF  
INSIDE COVER

FRONT

BACK

70% of actual size  
Digital Print - Belly Band Template

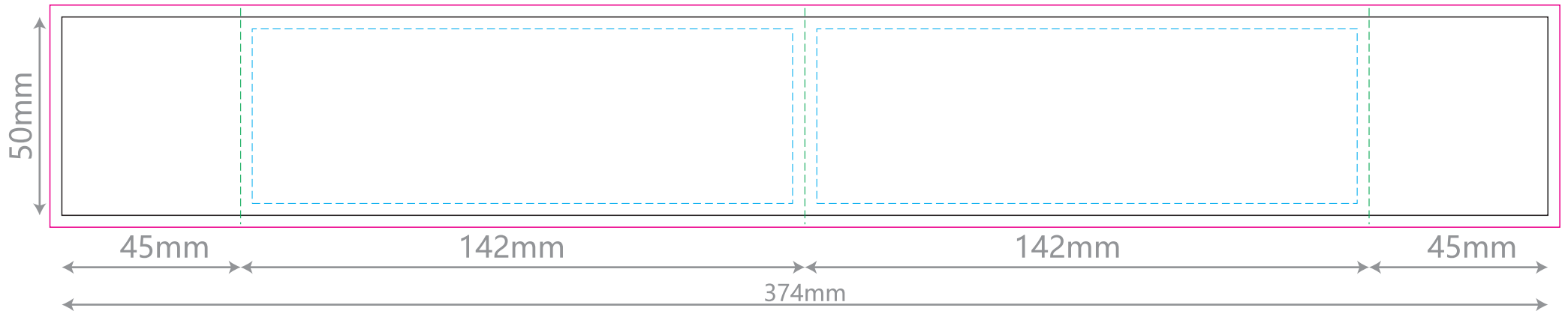

Blue Line = The SIGNIFICANT PRINT AREA  
(Keep all critical images & text within this box)  
Black Line = Maximum print area  
Pink Line = Bleed off to here  
Green Line = Fold

70% of Actual Size  
One colour - Inner custom pages  
Digital Print - Inner custom pages

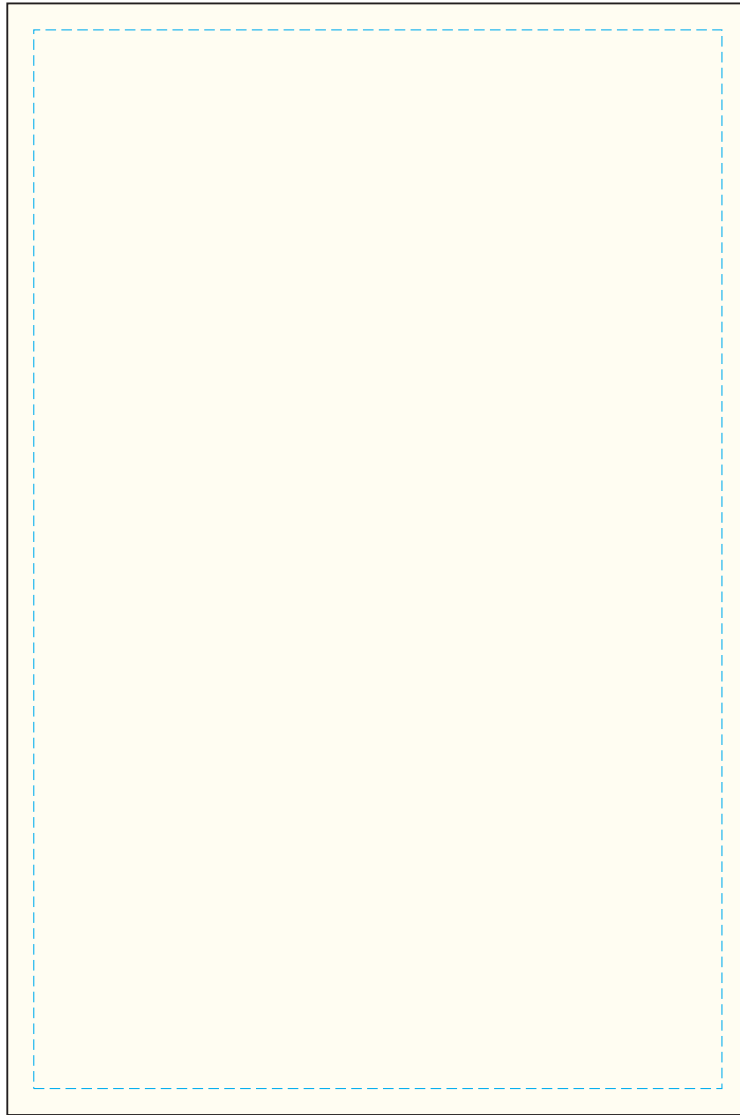

\_\_\_ out of 10 will be custom pages at the front of notebook

Blue Line = The SIGNIFICANT PRINT AREA  
(Keep all critical images & text within this box)  
Black Line = Maximum print area

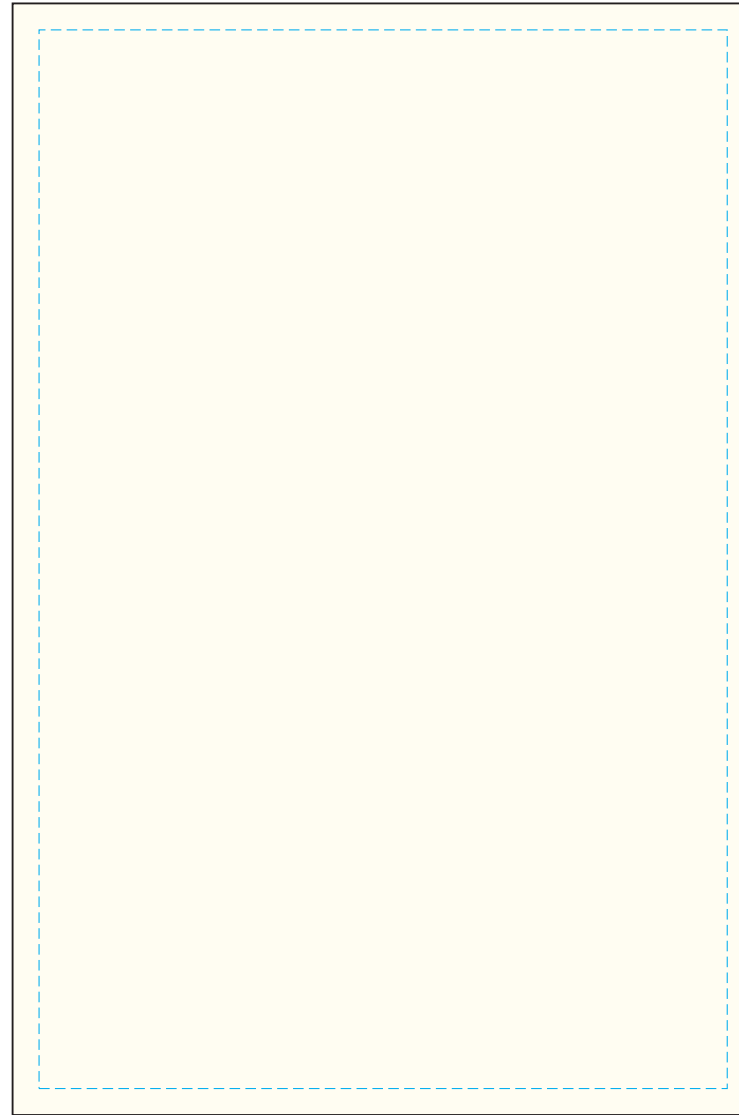

\_\_\_ out of 10 will be custom pages at the back of notebook

Blue Line = The SIGNIFICANT PRINT AREA  
(Keep all critical images & text within this box)  
Black Line = Maximum print area